

BERG

OKAP SPRING 90

Szerokość 90 cm

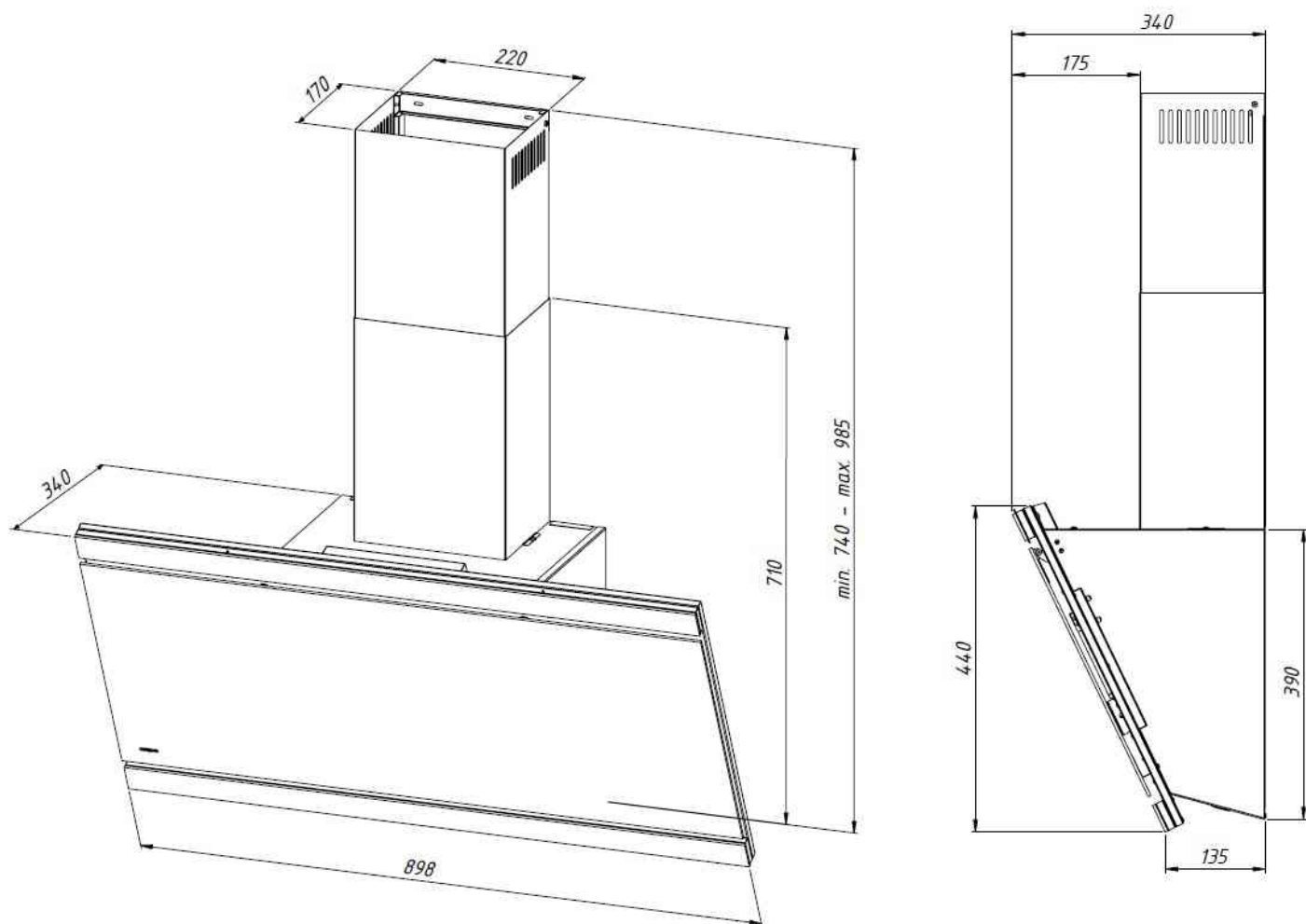

PRODUCENT: BERG Sp. z o.o., ul. Krakowska 61B,
71-017 Szczecin, tel. 48 91 485 47 60-68
berg-agd.pl; tres.net.pl